

COMMERCIAL GRADE PLUG-IN ADAPTER 24V

Driver for on/off, PWM dimming, and color-changing applications.

Date _____

Project Notes _____



24
VDC

FEATURES

- 24 Volt / 96 Watt
- Black Finish
- Short circuit, over current, over voltage, over temperature protections
- Fanless design / cooling by free-air convection
- UL Listed 1310 Class 2
- For use with commercial applications



ORDERING CODES

Driver and optional Junction Box

Diode LED	Model	Voltage/Wattage	Class	Color	Grade
DI					
	PA	24V96W (24 Volt / 96 Watt)	CL2 (Class 2)	B (Black)	CG (Commercial Grade)

RECOMMENDED TAPE LIGHTS

Inquire for Tape Lights not listed

- AlphaTECH® X
- BLAZE™
- BLAZE™ COLORS
- BLAZE™ ECO
- BLAZE™ ECO Wet Location
- BLAZE™ Mini
- BLAZE™ Wet Location
- BLAZE™ X
- BLAZE™ X Wet Location
- NEON BLAZE™
- NEON BLAZE™ MINI
- PURALIGHT®
- SPOTMOD® PUCK
- STREAMLITE™
- STREAMLITE™ RGBW
- VALENT®
- VALENT® Warm Dim
- VALENT® Warm Dim Wet Location
- VALENT® Wet Location
- VALENT® X

24V COMMERCIAL GRADE PLUG-IN ADAPTER - SPECIFICATION TABLE

Models	PA-24V96W
Input Voltage / Frequency	100-240V, 50-60 Hz
Maximum Load	96W
Output Voltage	24VDC
Efficiency	93% / PF>0.9
Class 2	Yes
Ambient Temperature	-22 - 158°F (-30 - +70°C)
Operating Temperature	-4 - 122°F (-20 - +50°C)
Minimum Load	No Minimum Load
Dimmable	PWM
Input Connection Type	Wire
Lead Wire A	72 inch AC Cable with 1-15P Plug
Output Connection Type	Wire
Lead Wire B	72 inch Male DC Barrel Connector, 2.1 x 5.5mm
Circuit Breakers	Auto Reset Hiccup
Environment	Indoor / Damp Location (IP20)
Working Humidity	5 - 95% RH non-condensing
Dimensions	5.5 x 2.4 x 1.4 in. (L x W x H)
Warranty	3 Year

COMMERCIAL GRADE PLUG-IN ADAPTER 24V

Driver for on/off, PWM dimming, and color-changing applications.

Date _____

Project Notes _____



MECHANICAL DIAGRAMS

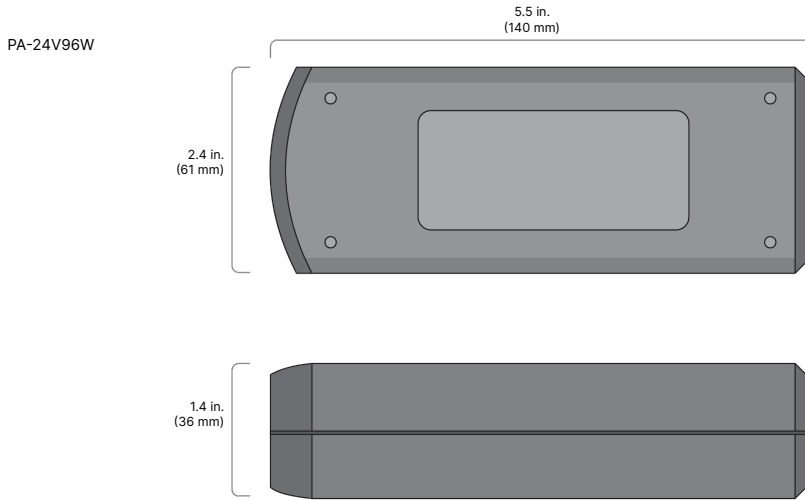

SYSTEM DIAGRAM

INLINE SWITCH / DIMMER

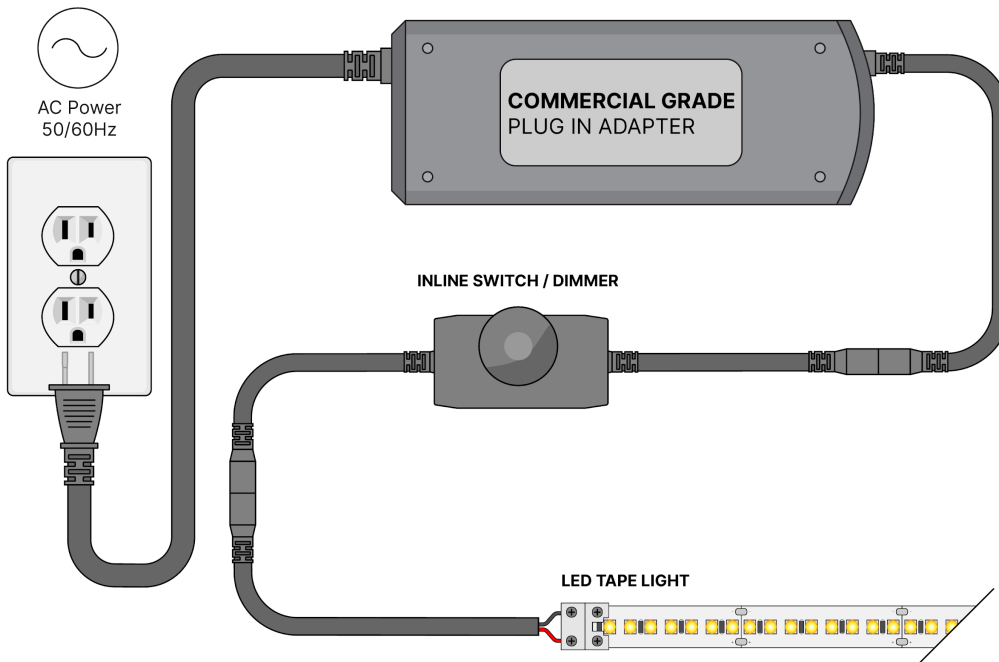

COMMERCIAL GRADE PLUG-IN ADAPTER 24V

Driver for on/off, PWM dimming, and color-changing applications.

Date _____

Project Notes _____



ACCESSORIES

DI-PVC2464-DL42-SPL-F

Adapter Splice Cable - Female, White, 42 in.

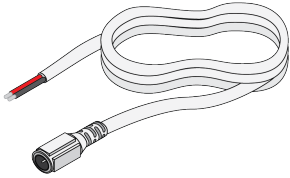

DI-PVC2464-DL42-SPL-F-B

Adapter Splice Cable - Female, Black, 39 in.

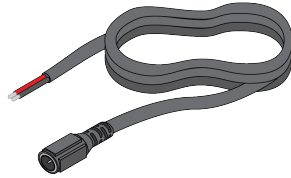

DI-0708

DC Extension Cable - White, 39 in.

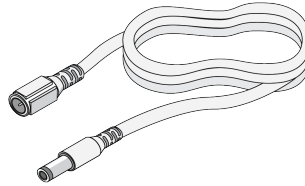

DI-0708B

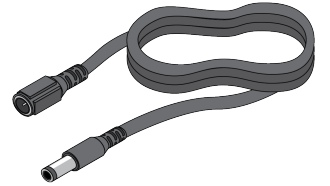

DI-0720

DC Splitter: 2-Way - White

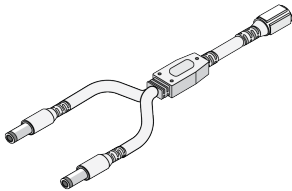

DI-0720B

DC Splitter: 2-Way - Black

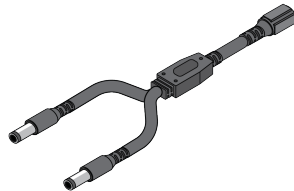

DI-0705

DC Splitter: 3-Way - White

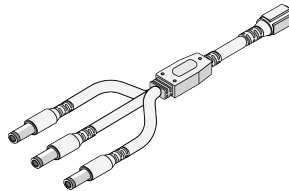

DI-0705B

DC Splitter: 3-Way - Black

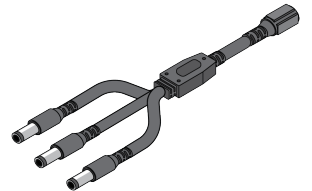

DI-DCSP4

DC Splitter: 4-Way - White

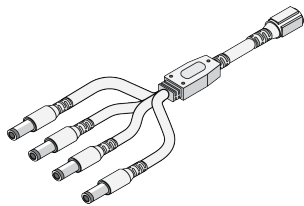

DI-0707

DC Splitter: 5-Way - White

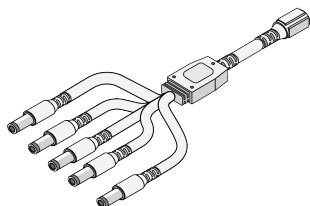

DI-0707B

DC Splitter: 5-Way - Black

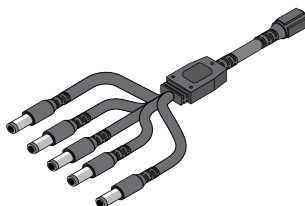

COMMERCIAL GRADE PLUG-IN ADAPTER 24V

Driver for on/off, PWM dimming, and color-changing applications.

Date _____

Project Notes _____



SWITCHES / DIMMERS

DI-INLINE-DS-5A-W

Inline Dimmer Switch, 5 Amp, White

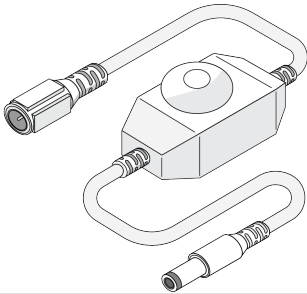

DI-INLINE-DS-5A-B

Inline Dimmer Switch, 5 Amp, Black



DI-INLINE-OS-5A-W

Inline On/Off Switch, 5 Amp, White

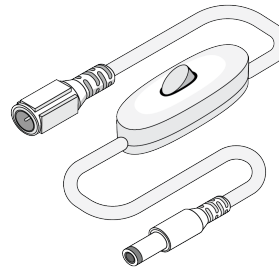

DI-INLINE-OS-5A-B

Inline On/Off Switch, 5 Amp, Black



DI-1710

Infrared LED On/Off Switch

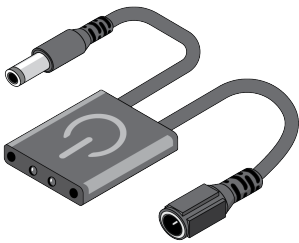

DI-1711

LIGHTTOUCH LED Dimmer Switch

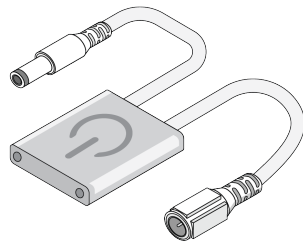

COMMERCIAL GRADE PLUG-IN ADAPTER 24V

Driver for on/off, PWM dimming, and color-changing applications.

Date _____

Project Notes _____



24
VDC

CERTIFICATIONS

Safety

- cULus (US & Canada) Listed, UL # E477211. ANSI/UL 1310. CAN/CSA-C22.2 No.250.13. Class 2 Power Units

Safety / Warnings / Disclosures

- Install in accordance with national and local electrical code regulations.
- This product is intended to be installed and serviced by a qualified, licensed electrician.
- Only use copper wiring. Use wires rated for at least 176°F (80°C) and certified for use with external connection of electrical equipment.
- Each maximum run requires a dedicated power feed from the driver. Do not extend beyond the recommended maximum run length.
- Tape light, attached wire leads, and additional extension cables, connectors, etc., are not rated for in-wall installation unless otherwise noted. Tape light and attached wire leads are field-cuttable.
- Ensure applicable wire is installed between driver, fixture, and any controls in-between. When choosing wire, factor in voltage drop, amperage rating, and type (in-wall rated, wet location rated, etc.). Inadequate wire installation could overheat wires, and cause fire.
- Do not install in environment where excessive heat may exist (ex. close proximity to fireplace, etc.) See Ambient Temperature ratings.
- Do not install indoor LED tape light products in outdoor / wet location environments. Only wet location tape light models are rated for outdoor / wet locations.
- Do not modify product beyond instructions or warranty will be void.
- Actual color may vary from what is pictured on this sheet and other print materials due to the limitations of photographic processes.
- We reserve the right to modify and improve the design of our fixtures without prior notice. We cannot guarantee to match existing installed fixtures for subsequent orders or replacements in regards to product appearance, CCT, or lumen output.

WARRANTY

Limited Warranty

- 3 Years

This warranty does not include the additional accessories referenced in this specification sheet. Complete warranty details for fixtures and additional accessories are available at www.diodeled.com/limited-warranty/ within the Policies section. For warranty related questions please contact product support.

Consumer's Acknowledgment

Elemental LED, Inc. stands behind its products when they are used properly and according to our specifications. By purchasing our products, the purchaser agrees and acknowledges that lighting design, configuration and installation is a complex process, wherein seemingly minor factors or changes in layout and in-field adjustments can have a significant impact on an entire system. Choosing the correct components is essential. Elemental LED is able to work with the original purchaser to make an appropriate product selection to the extent of the limited information that the customer can provide, but it is virtually impossible for Elemental LED to design a system that foresees every unknown factor. For this reason, this Warranty does not cover problems caused by improper design, configuration or installation issues. Any statement from a Elemental LED employee or agent regarding a customer's bill of goods and/or purchase order is NOT an acknowledgment that the products purchased are designed and configured correctly. The purchase agrees and acknowledges that it is the customer's responsibility to adhere strictly to all information contained in the Product Specification Sheets.

There is often more than one way to design, configure and layout an LED lighting application properly to achieve the same lighting effect. Elemental LED strongly recommends that licensed professionals be used in the design and installation of lighting systems that include Elemental LED products. The specifications include important information that a designer and installer should carefully review and strictly follow. Qualified designers and certified and/or licensed installers, with access to the final installation environment, customer goals, and Elemental LED product specifications can make the requisite decisions appropriate for a successful finished lighting application.

- Lumen value measured in accordance to IES LM-80-08. LED chips have a luminous flux range with a tolerance of +/- 5%.
- Each maximum run requires a dedicated power feed from the driver. Do not extend beyond the recommended maximum run length. Max run may exceed Class 2 limit. Actual wattage may differ from calculated wattage due to voltage drop across run.
- Do not install product in an environment outside the listed ambient temperature. Exceeding the maximum ambient temperature may damage LED chips, reduce the total lamp life, lumen output, and/or adversely impact color consistency.
- Actual efficacy value is dependent to specified LED driver (power supply). An estimated efficacy value can be calculated as follows: Lumen value divided by average power consumption per foot.
- Operating temperature is measured according to the minimum and maximum ambient temperature environment.